

INSTRUCTIONS
FOR USE

A-dec® 551sta

ASSISTANT'S INSTRUMENTATION

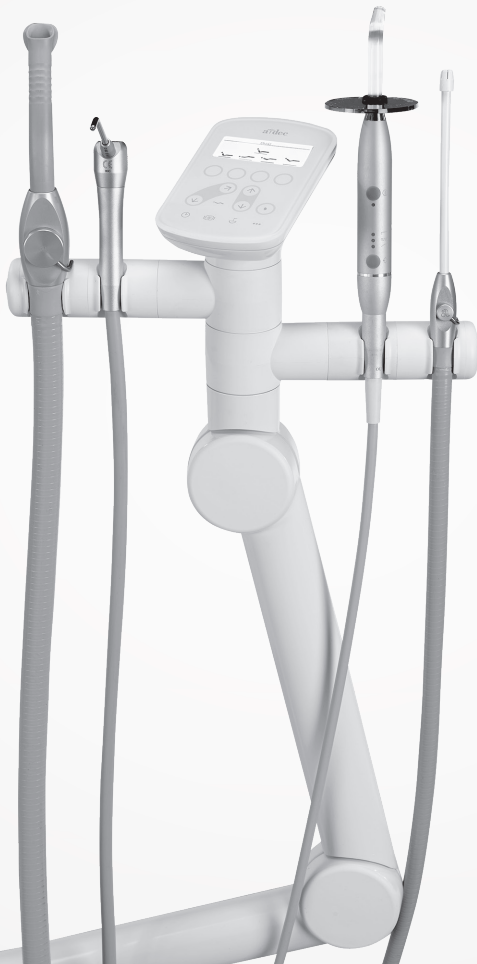

Copyright

© 2025 A-dec, Inc. All rights reserved.

A-dec, Inc. makes no warranty of any kind with regard to this material, including, but not limited to, the implied warranties of merchantability and fitness for a particular purpose. A-dec, Inc. shall not be held liable for any errors contained herein or any consequential or other damages concerning the furnishing, performance or use of this material. The information in this document is subject to change without notice. If you find any problems in the documentation, please report them to us in writing. A-dec, Inc. does not warrant that this document is error-free.

No part of this document may be copied, reproduced, altered, or transmitted in any form or by any means, electronic or mechanical, including photocopying, recording, or by any information storage and retrieval system, without prior written permission from A-dec, Inc.

Intellectual Property Rights

None of the trademarks, trade names, or proprietary symbols and icons in this document may be reproduced, copied, or manipulated in any manner without the express, written approval of the trademark owner.

A-dec, A-dec+, the A-dec design logo, and the trademarks listed at a-dec.com/legal/trademarks are A-dec trademarks or registered trademarks in the United States and other countries. Certain touch control symbols and icons are proprietary to A-dec, Inc.

Kerr and Dispos-a-Trap are trademarks or registered trademarks of the Kerr Corporation in the United States and may be trademarks or registered trademarks in other countries.

Regulatory Information and Warranty

For required regulatory information and the A-dec warranty, see the *Regulatory Information, Specifications, and Warranty* document (p/n 86.0221.00) available in the Resource Center at www.a-dec.com.



For quick access to this document online, scan, tap, or click this QR code, which points to: a-dec.com/regulatory-guide.

Product Service

Product service is available through your local authorized A-dec dealer. For service information, or to locate an authorized dealer, contact A-dec at 1.800.547.1883 in the USA and Canada or +1.503.538.7478 worldwide, or visit www.a-dec.com.

Product Models and Versions Covered in This Document*

Models	Versions	Description
551sta	n/a	Assistant's Instrumentation

* Equipment shown in this document may include optional features or accessories. Some products, versions, and options in this document may not be available in certain regions.

Content Map

HVE/Saliva Ejector..... 4, 9

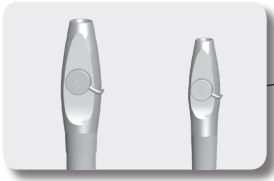

Holder Adjustment.....5

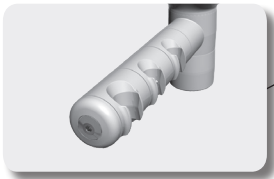

Solids Collector.....8

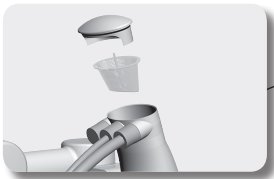

Control Pad.....3



Syringe.....4



Barriers.....6

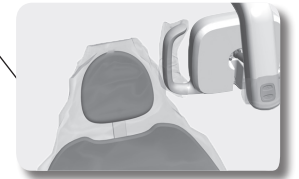

Operate / Adjust	2
Clean / Maintain.....	6
Specifications	14

Operate/Adjust

Turn On/Turn Off the Air, Water, and Power



Chairs with Delivery and Support Systems

If you have a chair with an attached system, use the master toggle to turn on the power, water, and air. The master toggle is normally located on the delivery system, but may instead be located on the support center or floor box on chairs without a delivery system.

If there is no power to the system, verify that the power button on the chair is pressed in. This button must be on in order for the master toggle to control system power.

When to Turn Off the Power

To save energy and reduce the chance of air leaks, press the power button to turn off power at the end of the day and before longer periods of non-use.

A-dec Control Pads*



For touchscreen and control pad use, see the *A-dec DS7/CP5i/CP5 Touch Controls Instructions for Use* (p/n 86.0857.00) at a-dec.com/touchscreen-manual.



For configuring connectivity features, see the *A-dec+™ Software Platform Instructions for Use* (p/n 86.1030.00) at a-dec.com/connectivity-manual.



*Note. Touch control symbols and icons are proprietary to A-dec, Inc.

Operate the Autoclavable Syringe

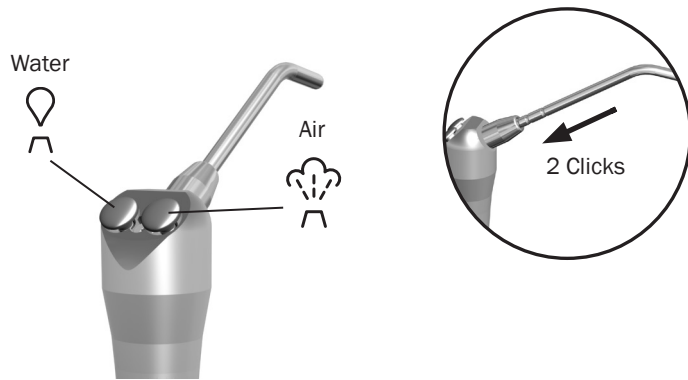

To install the A-dec syringe tip, push the tip in until you feel two clicks. Press both buttons simultaneously for the air/water spray.



IMPORTANT For more details on syringe usage and maintenance, see your A-dec syringe Instructions for Use.

A-dec HVE/Saliva Ejector Left/Right Conversion

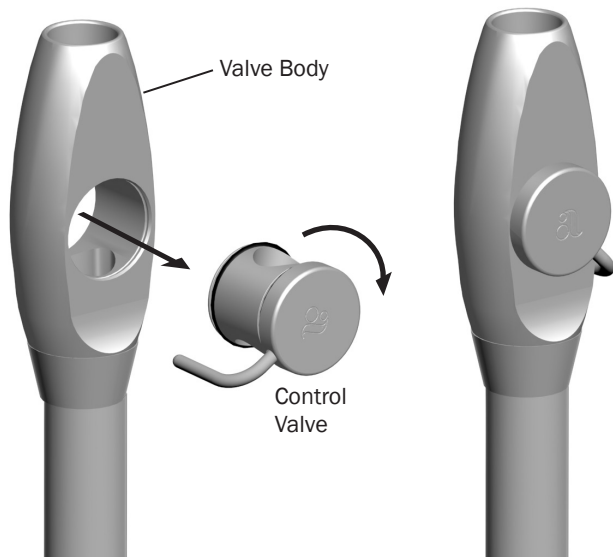

To convert the standard high-volume evacuator (HVE) and saliva ejector for left-handed operation, push the control valve out of the valve body, rotate the control valve 180°, and push it back into place.



NOTE Be sure to reinstall the valve on the same side of the valve body. Otherwise, the HVE or saliva ejector will not operate properly.

Position the Handpiece Holders

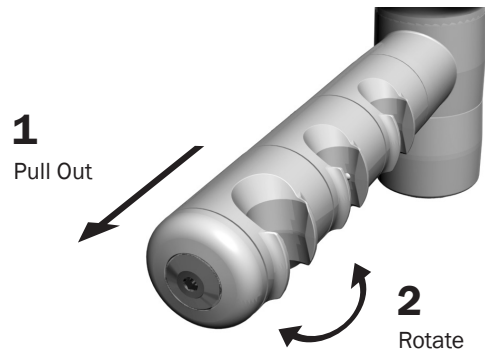

CAUTION Twisting the holder without pulling it away from the adjacent one will damage the mechanism.

You can adjust the instrument holders independently or as a set (on the doctor's side and the assistant's side).

1. Pull the holder, or holders, away from the control pad/handle.
2. Rotate to the desired position and release.

Auto-Electric Holders

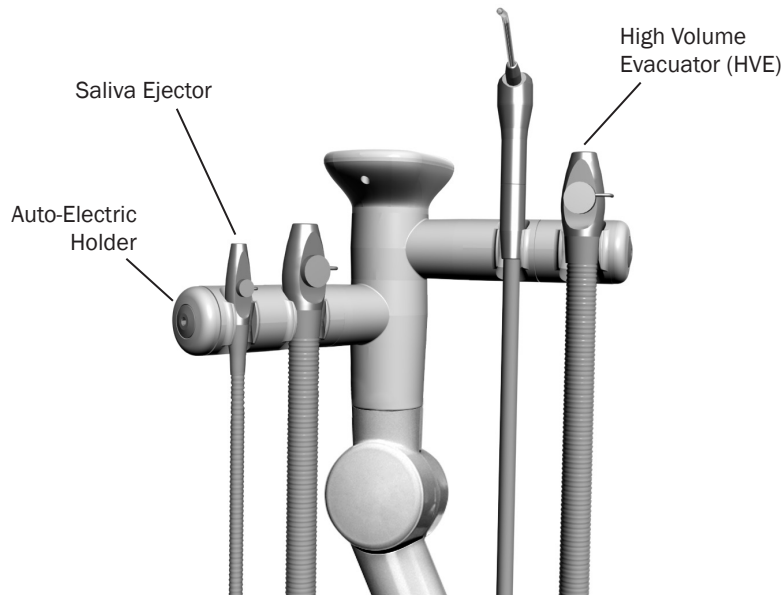

If you have a chair-side vacuum system and auto-electric holders, lift the HVE or saliva ejector from its holder and open the valve to turn on the vacuum. Return the instrument to its holder to turn off the vacuum.

Clean/Maintain

Protect with Barriers

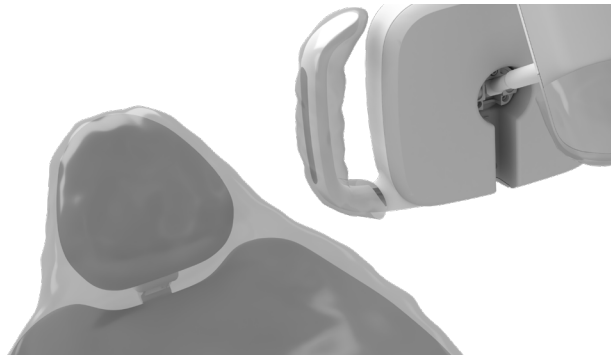

NOTE For proper use and disposal of barriers, see the barrier manufacturer's Instructions for Use.



IMPORTANT For recommendations on cleaning and chemical disinfection of touch and transfer surfaces (where barrier protection is not applicable or when barriers are compromised), please see the *A-dec Equipment Asepsis Guide* (p/n 85.0696.00).

A-dec recommends barrier protection for all applicable touch and transfer surfaces. Touch surfaces are areas that come into contact with hands and become potential cross-contamination points during dental procedures. Transfer surfaces are areas that come into contact with instruments and other inanimate objects.

In the USA, barriers must be produced under the Current Good Manufacturing Practice (CGMP) as specified by the U.S. Food and Drug Administration (USFDA). For regions outside the USA, refer to the medical device regulations specific to your location.

Waterline Maintenance



A-dec recommends that you use ICX Renew® dental unit waterline shock treatment* before you use the system for the first time.

For on-going waterline maintenance, A-dec recommends a three-part protocol:

- Continuous use of A-dec ICX® waterline treatment tablets
- Regularly monitor the water quality in your dental equipment
- Shock treatment whenever the test results exceed your established water quality action level



IMPORTANT For complete details on how to maintain good water quality, see the appropriate Instructions for Use provided with your A-dec waterline maintenance products. For quick access to these documents online, scan, tap, or click the QR code below.



* Note. ICX Renew may be sold under different names in different regions.

Maintain the Solids Collector

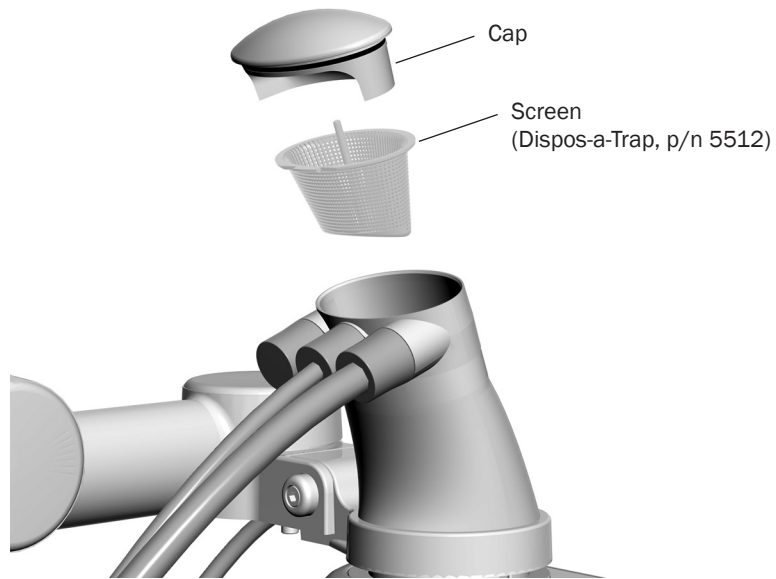

WARNING Infectious waste may be present. Follow asepsis protocol to prevent cross contamination.

The solids collector helps prevent solids from entering the central vacuum system. To ensure proper suction from the central vacuum and maintain proper treatment room asepsis, discard and replace the solids collector screen at least twice a week.



TIP To obtain replacement solids collector screens, contact your authorized A-dec dealer and reference the Kerr® Dispos-a-Trap™ p/n 5512.

To replace the solids collector screen:

1. Turn off the vacuum or open the HVE control valve.
2. Remove the solids collector cap.



CAUTION Do not empty the screen into your cuspidor. Doing so could plug the drain.

3. Remove the solids collector screen and discard according to your local regulations.



NOTE When you replace the solids collector cap, ensure that the keyed cutout faces the tubing (as shown above), or it will cut off the vacuum flow.

4. Insert a new screen in the solids collector and replace the cap.

A-dec HVE/Saliva Ejector Valve Body Assembly Asepsis

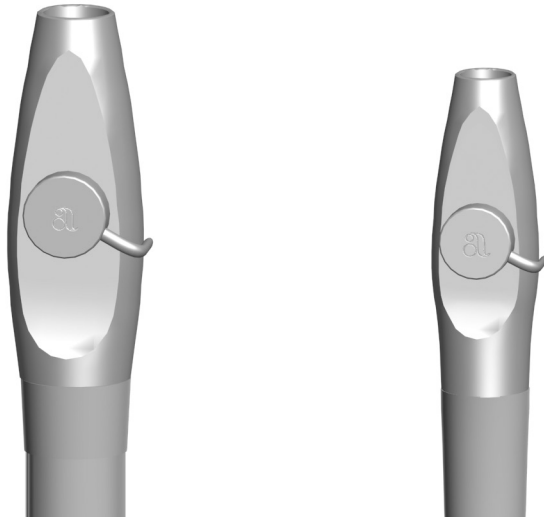

NOTE Vacuum lines should be flushed at the end of each day or more frequently according to your clinic's protocols.

If you use barriers to protect the main body of the HVE and saliva ejector, replace the barriers after each patient. Clean and disinfect these instruments at the end of each day or after each patient if the barriers have been compromised. If you do not use barriers, or if you perform oral surgery, always clean and disinfect these instruments after each patient.

Cleaning and Disinfection



CAUTION Clean the valve body assembly as soon as possible after treating each patient. Do not allow blood and debris to dry on instruments. If you cannot clean it immediately, keep the valve body assembly moist.



NOTE Use an intermediate-level EPA-registered hospital-grade disinfectant containing a tuberculocidal claim with one of the following compositions: high-dilution water-based phenolic formulation or quaternary ammonium compound with less than 25% isopropanol.



NOTE If using a spray solution, spray on a soft, low-lint wipe to apply solution to the valve body assembly.

To clean and disinfect the HVE and saliva ejector valve body assembly without disconnecting from the vacuum system:

1. Remove the vacuum tip from the HVE or saliva ejector valve body assembly. Discard disposable vacuum tips.

A-dec HVE/Saliva Ejector Valve Body Assembly Asepsis *(continued)*

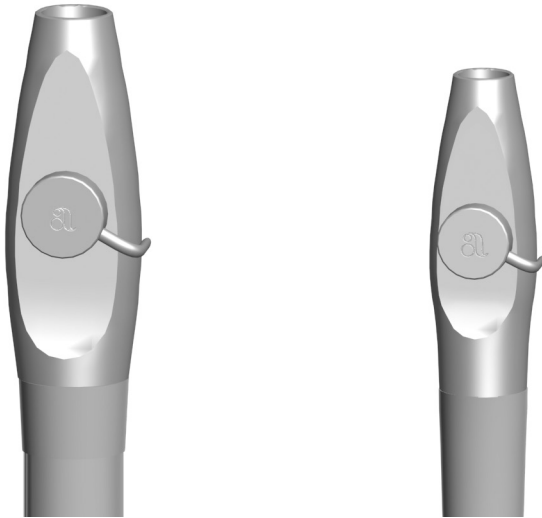

2. Clean the valve body assembly to remove visible soil using a disinfectant wipe or spray solution. Keep the valve body assembly wet according to the manufacturer's recommended contact time. Repeat, if necessary, until the valve body assembly is visibly clean.
3. Disinfect the valve body assembly using a new disinfectant wipe or spray solution. Keep the valve body assembly wet according to the manufacturer's recommended contact time.
4. Allow the valve body assembly to air dry.
5. Operate the HVE and the saliva ejector valves several times to verify that they rotate smoothly.

Routine Maintenance and Sterilization



CAUTION Clean the valve body assembly as soon as possible after treating each patient. Do not allow blood and debris to dry on instruments. If you cannot clean it immediately, keep the valve body assembly moist.



NOTE A-dec valve body assemblies are heat tolerant for sterilization. Users may sterilize at their discretion.

To routinely maintain and sterilize the HVE and saliva ejector when disconnected from the vacuum system (frequency determined by the user):

1. Remove the valve body assembly from the vacuum line by pulling it away from the tubing at the tailpiece.
2. Disassemble the valve body by pushing the control valve out of the valve body.
3. Clean soiled valve body components using a soft, low-lint wipe.

A-dec HVE/Saliva Ejector Valve Body Assembly Asepsis *(continued)*

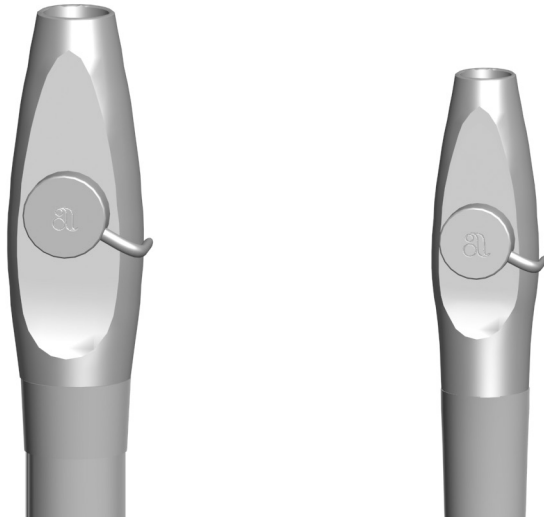

4. Prepare a warm (32-43°C [90-110°F]) detergent solution (neutral pH enzymatic detergent or alkaline non-enzymatic detergent), according to the manufacturer's recommended instructions.
5. Soak soiled valve body components in the prepared detergent solution for at least one minute or for as long as the manufacturer's recommended instructions indicate (whichever is longer).
6. Inspect O-rings. Remove, discard, and replace if there are visible signs of damage.
7. Use a soft, nylon-bristle brush, or equivalent, to scrub the:
 - Exposed surface of the valve body components, while submerged, for a minimum of 30 seconds or until all visible soil has been removed.
 - Interior lumen of the valve body at least three times (in and out), clearing any visible soil from brush bristles.
8. Rinse the cleaned valve body components under flowing, warm (32-43°C [90-110°F]) potable water for a minimum of 30 seconds.
9. Allow valve body components to air dry.
10. Sterilize the valve body components according to the following:
 - Dynamic air-removal sterilizers: 4 minutes at 132-135°C (270-275°F)
 - Gravity-displacement sterilizers: 30 minutes at 121-123°C (250-254°F)
11. Allow the load to dry for 30 minutes before removing it from the sterilizer. Ensure the valve body components are completely dry before proceeding.

A-dec HVE/Saliva Ejector Valve Body Assembly Asepsis *(continued)*

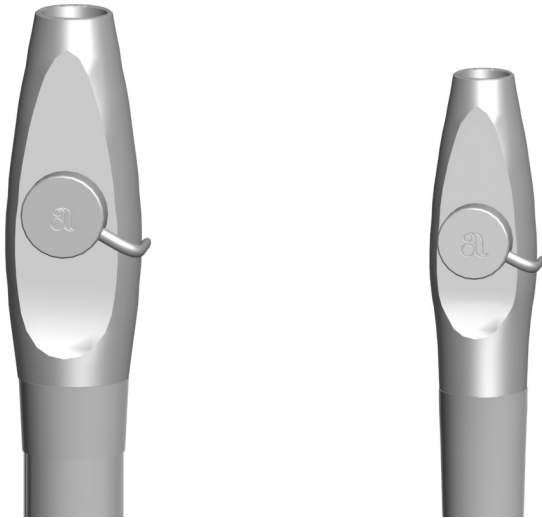

CAUTION Use only silicone lubricant when lubricating the black O-rings in A-dec instruments. Petroleum-based products will cause permanent damage to the O-rings.

12. Prior to use, lubricate O-rings with A-dec silicone lubricant, and reassemble the valve body assembly.
13. Reinstall the valve body assembly on the tubing tailpiece.
14. Operate the HVE and the saliva ejector control valves several times to verify that they rotate smoothly.

A-dec HVE/Saliva Ejector Tips



NOTE Select tips that are compatible with your HVE and saliva ejector openings. See “A-dec HVE/Saliva Ejector Tip Connections” on page 14 for specifications.

Disposable Tips



CAUTION Disposable HVE and saliva ejector tips are not sterilizable and should not be reused.



Replace disposable HVE and saliva ejector tips after each use.

Access the Utilities

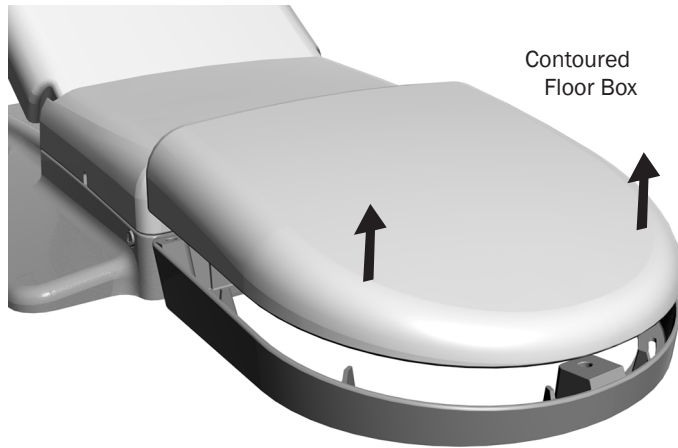

WARNING Shock hazard. When you remove or replace the covers, take care not to damage any wiring or tubing. Verify that the covers are secure after you replace them.

The system utilities are located in the contoured floor box under your chair and typically include the electrical outlet, as well as the system hookups for air, water, and vacuum. To access, lift the cover up and off the floor box frame. For maintenance, contact your local authorized A-dec dealer.

Specifications



A-dec HVE/Saliva Ejector Tip Connections

Standard 11 mm HVE:	11 mm (0.433") diameter opening <i>(for standard HVE tips)</i>
Large bore 15 mm HVE:	15 mm (0.591") diameter opening <i>(for large bore HVE tips)</i>
Standard 6 mm SE:	6 mm (0.236") diameter opening <i>(for standard SE tips)</i>

Solids Collector Screen/Filter

Maximum mesh opening size: 0.047" (1.194 mm) \cong 1200 μ m



IMPORTANT For electrical specifications, identification of symbols, and other regulatory requirements, see the *Regulatory Information, Specifications, and Warranty* document (p/n 86.0221.00) available in the Resource Center at www.a-dec.com.



For quick access to this document online, scan, tap, or click this QR code, which points to: a-dec.com/regulatory-guide.



NOTE Specifications are subject to change without notice. Requirements may vary depending on your location. For more information, contact your authorized A-dec dealer.



 **A-dec Headquarters**

2601 Crestview Drive
Newberg, Oregon 97132
United States
Tel: 1.800.547.1883 within USA/CAN
Tel: +1.503.538.7478 outside USA/CAN
www.a-dec.com

A-dec Australia

Unit 8, 5-9 Ricketty Street
Mascot, NSW 2020
Australia
Tel: 1.800.225.010 within AUS
Tel: +61.(0).2.8332.4000 outside AUS

A-dec United Kingdom

Austin House, 11 Liberty Way
Nuneaton, Warwickshire CV11 6RZ
England
Tel: 0800.ADEC.UK (2332.85) within UK
Tel: +44.(0).24.7635.0901 outside UK



86.1024.00 Rev B
Date of Issue 2025-01-30
Copyright 2025 A-dec, Inc.
All rights reserved.

IFUnewcov5